

G-1000-2S2



SHALLOW BURIAL TANKS – To maximum 2' overburden
DEEP BURIAL TANKS – To maximum 7' overburden
PUMP-OUT TANK - Pump chamber - 2 sizes available
EXTRA DEEP BURIAL TANKS are available as a special order



The Guardian Guarantee

Equinox Industries Guardian tanks are warranted for 10 years against defects in materials and workmanship and will perform according to our specifications provided that installation is proved to be satisfactory to Equinox Industries Ltd.. For a full statement of warranty contact Equinox Industries Ltd.

1-Piece Fiberglass Tanks

G-1000-2S2



MANHOLE SLEEVES	
LENGTH	SLEEVE REQUIRED
305 [12]	1 X E-MES-12
457 [18]	1 X E-MES-18
610 [24]	1 X E-MES-24
762 [30]	1 X E-MES-30
1524 [60]	1 X E-MES-60
2134 [84]	1 X E-MES-84

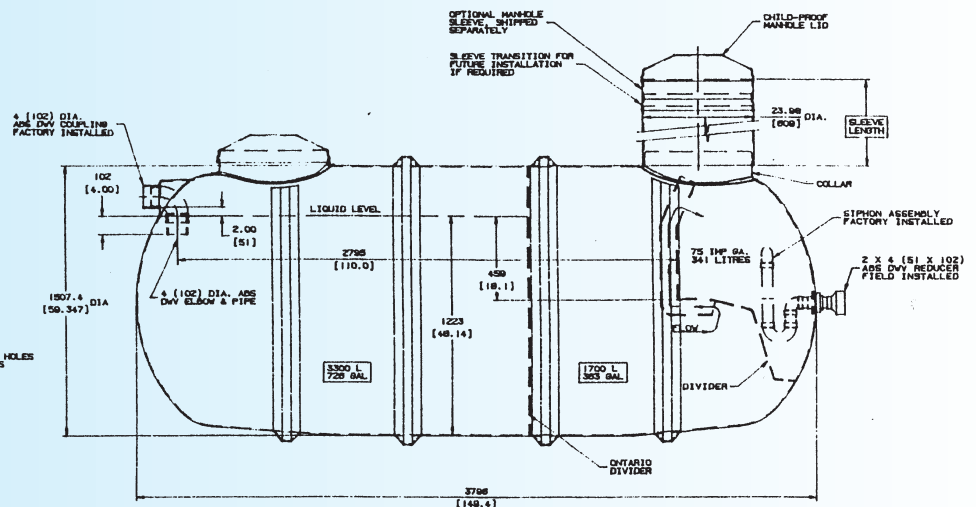
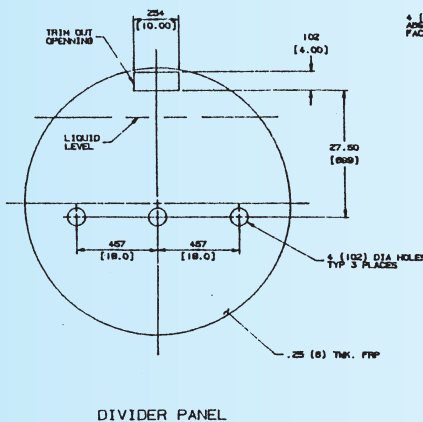
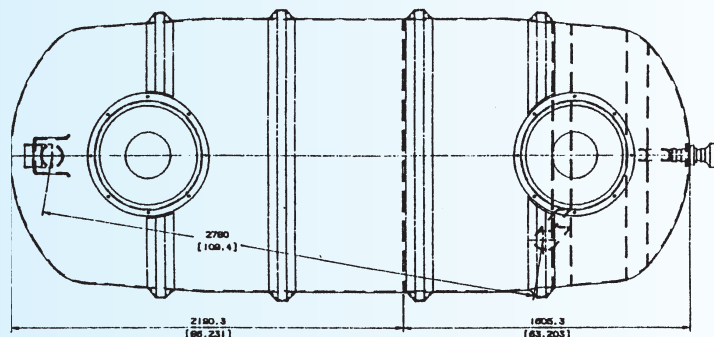

Model	Style	Dimensions In./mm	Reccomendation	Compartments	Burial Depth In./mm
G-1000-2S2	Siphon	64 x 143 (1626 x 3632)	3 Bedrooms	3 Compartments	24 (610) or 86 (2184)

Additional Manway sleeves are available as required.